

Article number: 58EPLJ6

Description: Fitting EPLJ6 angle reduction
tube diameter 6 - 6

Measures

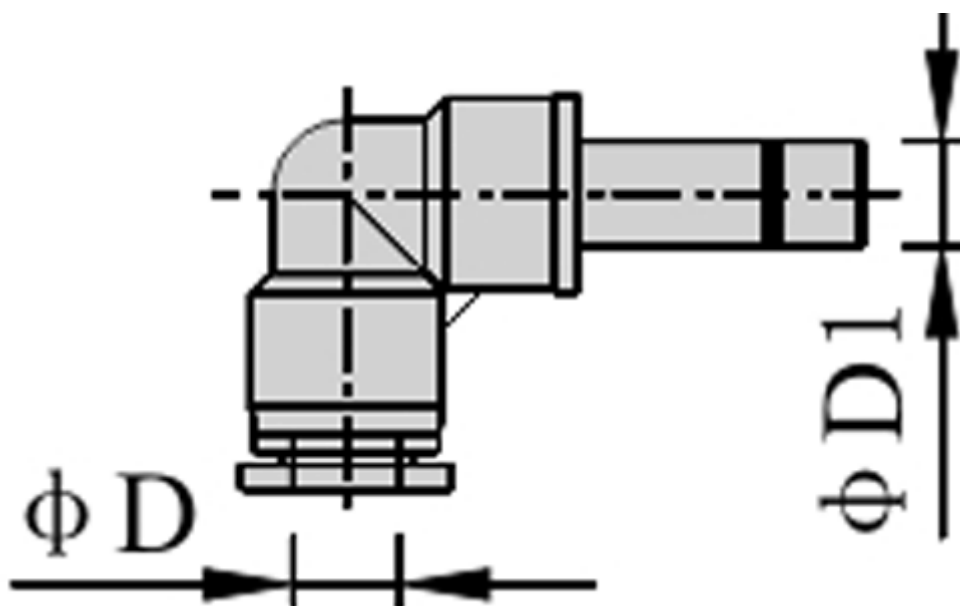

D = 6

D1 = 6